

Switching Power Supply Type SPD 100W DIN rail mounting

CARLO GAVAZZI



- Installation on DIN Rail 7.5 or 15mm
- Short circuit protection
- PFC standard
- Power ready output on 24VDC
- LED indicator for DC power ON
- LED indicator for DC low
- Standard parallel function
- Very compact dimensions
- UL, cUL listed and TUV/CE approved
- Class I div2 certification (in progress)

Product Description

This SPD is the most compact 100W power supply on the market. Relay output for "power ready" parallel function and PFC are included. Performances are unique with high efficiencies and the possibility of being used up to 70°C with a little derating.

Ordering Key

SP D 24 100 1

Model _____
 Mounting (D = Din rail) _____
 Output voltage _____
 Output power _____
 Input type _____

Input type: 1= single phase

Approvals



Output Performances

Model	Rated output Voltage (VDC)	Output Power (W)	Output Current (A)	Voltage Trim Range		DC ON LED (VDC) Threshold at startup		DC LO LED (VDC) Threshold after startup		Typical Efficiency
				Min. VDC	Max. VDC	Min.	Max.	Min.	Max.	
SPD12100	12	100.8	8.4	11.4	14.5	10	11.2	10	11.2	84%
SPD24100	24	100.8	4.2	22.5	28.5	17.6	19.4	17.6	19.4	86%
SPD48100	48	100.8	2.1	47.0	56.0	37.0	43.0	37.0	43.0	88%

Output Data

Output voltage accuracy	-0 +1% max (factory adjusted)	Rise Time	
Line regulation	± 1%	$V_{i\ nom}, I_{o\ nom}$	150ms
Load regulation		$V_{i\ nom}, I_{o\ nom}$ with Capacitor load	500ms
Non parallel model	± 1%	Capacitor Load	
Parallel model	± 5%	12V, 24V versions	7000µF
Temp. coefficient	± 0.03% / °C	48V version	3500µF
Ripple and noise	50mV	Reverse Voltage Immunity	
$V_{i\ nom}, I_{o\ nom}, BW=20MHz$		12V	18V
Rated continuous Loading	8.4A @ 12VDC / 6.9A @14.5VDC 4.2A @ 24VDC / 3.5A @ 28.5VDC 2.1A @ 48VDC / 1.8A @ 56VDC	24V	35V
Fall Time	150ms	48V	63V
Transient recovery time		Hold up Time $V_i = 115VAC$ $I_{o\ nom}$	15ms
$V_{i\ nom}, I_{o\ nom}$	2ms	Hold up Time $V_i = 230VAC$ $I_{o\ nom}$	30ms
Turn On Time		Minimum load $V_{i\ nom}$	0%
$V_{i\ nom}, I_{o\ nom}$	1.0s	Parallel Operation	3 units max.
$V_{i\ nom}, I_{o\ nom}$ with Capacitor load	1.5s	0.1 $I_{o\ min}$ ~ 0.9 $I_{o\ max}$	

Input Data

Rated input voltage	110/240	Internal Voltage Surge Protection (acc. to IEC61000-4-5)	Varistor
Voltage range AC in DC in	90 - 264VAC 120 - 375VDC	Leakage Current Input / Output Input / FG	0.25mA 3.5mA
Rated input current	1.65A / 1.4A	Inrush current Vi= 115VAC Vi= 230VAC	30A 60A
Power dissipation 12V 24V 48V	18.5W 15W 14W	P.F.C.	0.7
Frequency range	47 - 63Hz		

Controls and Protections

Input Fuse	T3.15/250VAC internal ¹⁾	Input Voltage Surge Protection	Varistor
Output Short Circuit	fold forward	Power ready (only SPD241001) Threshold at start up (contact closed) Contact rating at 60VDC Insulation	Min. 17.6VDC - Max.19.4VDC 0.3A 500VDC
Rated Overload Protection	110 - 140%		
Over voltage protection (auto recovery) 12V model 24V model 48V model	14.5V to 17.4V 30.0V to 33.0V 60.0V to 66.0V		

¹⁾ Fuse not replaceable by user

General Data (@ nominal line, full load, 25°C)

Ambient temperature	-25°C to 71°C	MTBF (Bellcore Issue 6@40°C), GB 12V model 24V model 48V model	448.000h 456.000h 490.000h
Derating (>61°C to +71°C)	2.5% / °C	Altitude during operation	3.000m
Ambient humidity	20 to 95%RH	Case material	Plastic
Storage	-25°C to +85°C	Dimensions L x W x D	90 x 54 x 114mm
Pollution degree	2	Weight	430g
Protection degree	IP20		
Cooling	Free air convection		
Switching frequency Min. Max.	45kHz 60kHz		

Approvals and EMC

Insulation voltage Input / Output Input / FG	3.000VAC / 4242VDC 1500VAC / 2121VDC	CE	EN 61000-6-3, EN 55022 Class B, EN 61000-3-2, EN 61000-3-3 EN 61000-6-2, EN 55024, EN 61000-4-2 Level 4, EN 61000-4-3 Level 3 EN 61000-4-4 Level 4, EN 61000-4-5 L-N Level 3, L / N-FG Level 4 EN 61000-4-6 Level 3, EN 61000-4-8 Level 4, EN 61000-4-11 ENV 50204 Level 2, EN 61204-3
Insulation resistance	100MΩ min		
Shock resistance	acc. to IEC 60068-2-27 (15G, 11ms, 3 Axis, 6 Faces, 3 times for each Face)		
Vibration resistance	acc. to IEC 60068-2-6 (Mounting by rail: 10-500 Hz, 2G, along X, Y, Z each Axis, 60 min for each Axis)		
UL / cUL	UL 508 Listed UL 60950-1, Recognized ISA 12.12.01 (Class I, Division 2, Groups A, B, C and D in progress)		
TUV	EN 60950-1, CB scheme EN 61558-1, EN 61558-2-17 (acc.to EN 60204)		

Block Diagrams

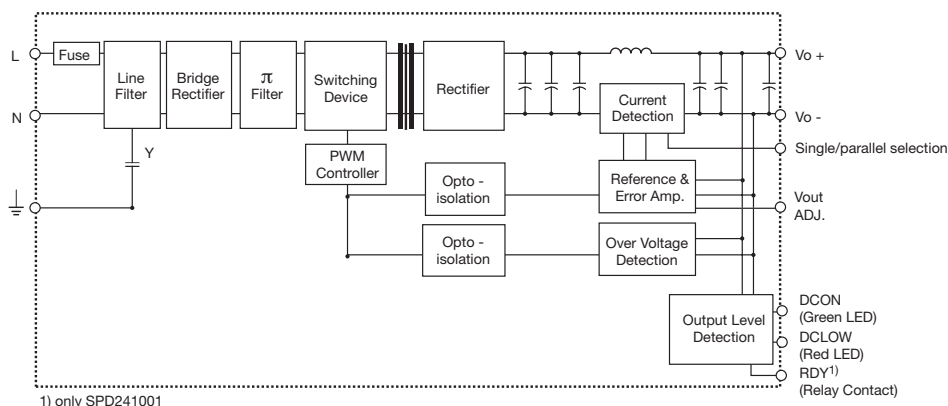

Pin Assignment and Front Controls

Pin No.	Designation	Description
1	RDY	NO relay contact for DC OK (only SPD241001)
2	RDY	NO relay contact for DC OK (only SPD241001)
3	V+	Positive output terminal
4	V+	Positive output terminal
5	V-	Negative output terminal
6	V-	Negative output terminal
7	GND	Ground terminal to minimise High frequency emissions
8	N	Neutral input (no polarity with DC input)
9	L	Phase input (no polarity with DC input)
L1	DC ON	DC output ready LED
L2	DC LO	DC low indicator LED
POT1	Vout ADJ.	Trimmer for fine output voltage adjustment
SW1	S/P	Single / Parallel select switch

Typ. Efficiency Curve

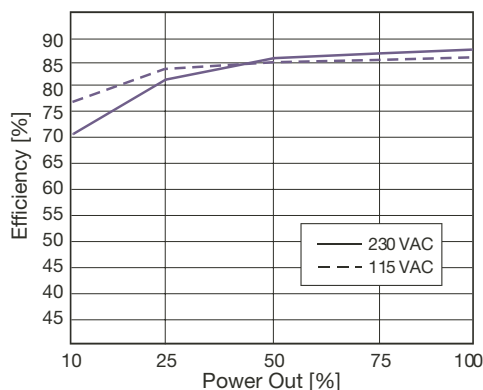

Derating Diagram

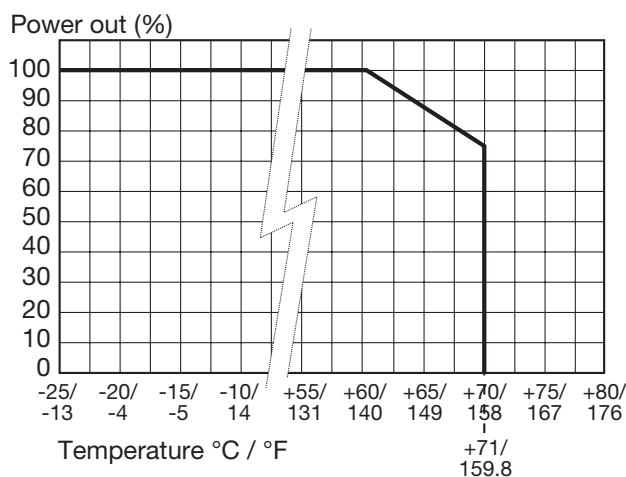

Typ. Current Limited Curve

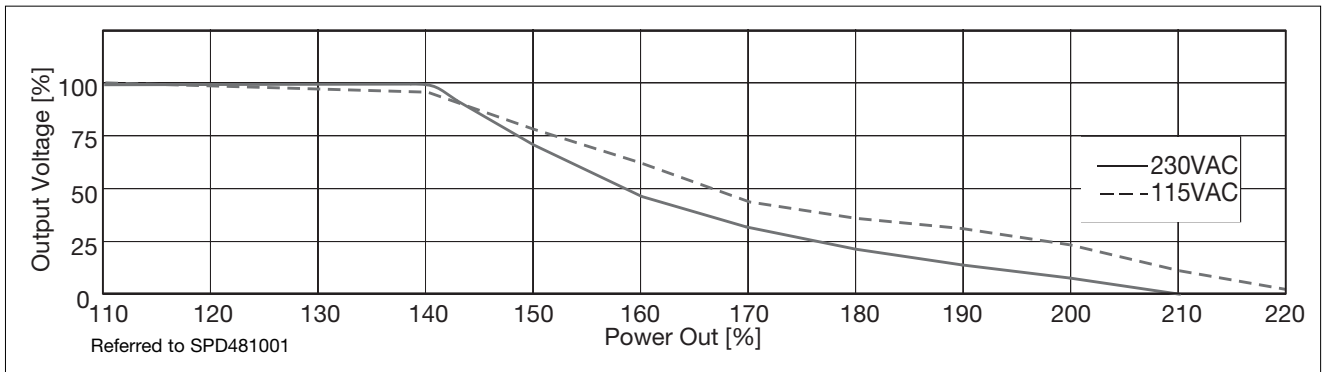
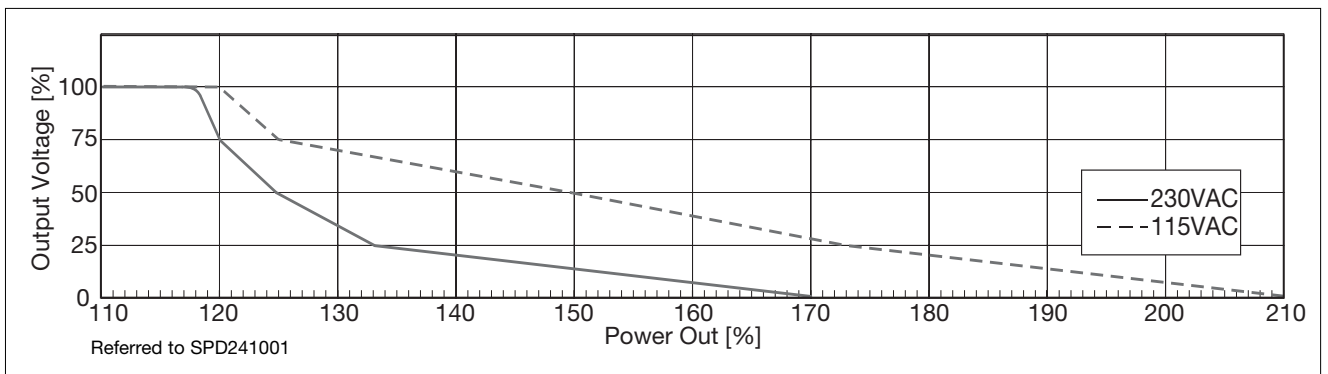
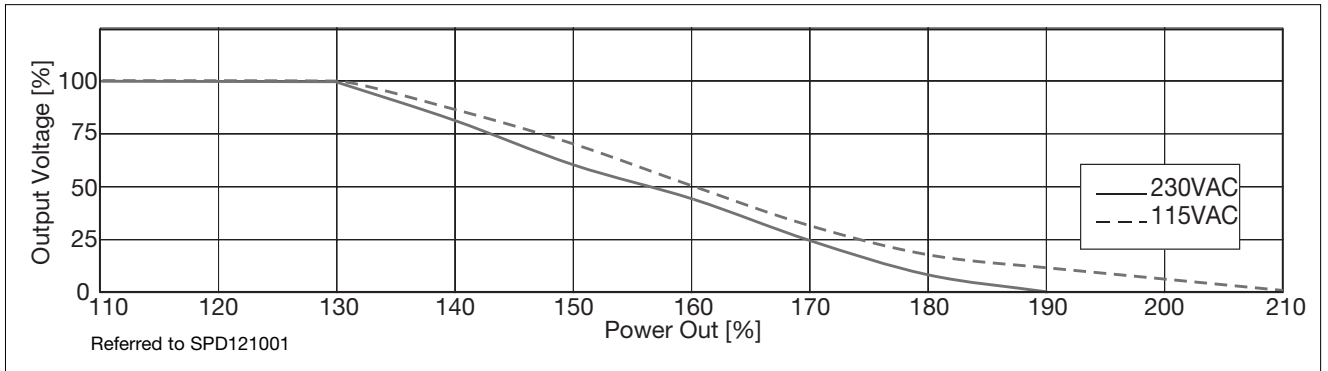

Mechanical Drawings mm (inches)

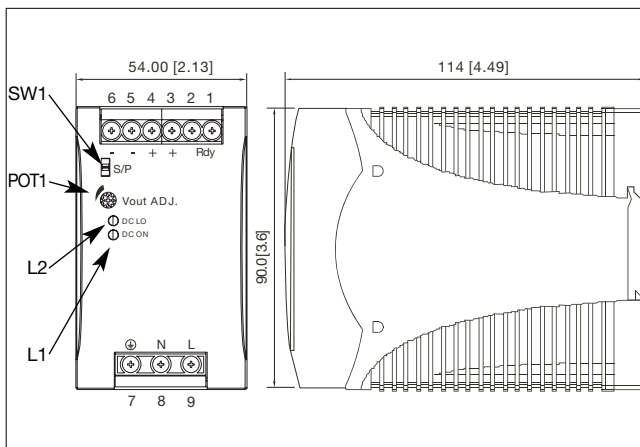

Installation

Ventilation and cooling	Normal convection All sides 25mm free space for cooling is recommended
Screw terminals	10-24AWG flexible or solid cable 8mm stripping recommend
Max. torque for screws terminals	Input terminals 1.008Nm (9.0lb-in) Output terminals 0.616Nm (5.5lb-in)
Plug-in connectors	10-24AWG flexible or solid cable 7mm stripping recommend
Max. torque for plug-in terminals	Input terminals 0.784Nm (7.0lb-in) Output terminals 0.784Nm (7.0lb-in)
Recommended circuit breaker	5A / 6A / 10A B, D characteristics